



**Innovation In and
Out of Parlour**

CR35 Milking Point Control Manual

Version - 1.0

Date - October 2017



Index

Manual Version.....	5
About the Milking Point Control.....	6
Installing the ACR Sensor.....	8
Installing the Milking Point Control.....	8
Milking Point Control Wiring Connections.....	9
396W Switch Mode Power Supply Wiring Connections.....	11
System Wiring Overview	12
Setting up the Milking Point Control.....	13
Accessing the Settings.....	13
The Setup Menu.....	13
The M2Bus Settings Menu.....	15
The Stall Number Setting.....	15
The Parlour Type Setting.....	16
The Stall Width Setting.....	17
The ACR Settings Menu.....	18
The Animal Type Setting.....	18
The ACR Mode Setting.....	19
The ACR Hold Off Setting.....	20
The Kick Off Delay Setting.....	20
The ACR Timer Setting.....	21
The ACR Pull Off Resistance Setting.....	21
The Milking Time Setting.....	22
The Vacuum Delay Setting.....	23
The Purge Setting.....	23
The Purge Hold Off Setting.....	24
The Start Input Is Edge Setting.....	24
The Swing to Start Setting.....	25
The Conductivity Settings Menu.....	26
The Conductivity Global Enable Setting.....	26
The Conductivity Warning Level Setting.....	26
The Conductivity Pull Off Level Setting	27
The Pulsation Settings Menu.....	28
The Pulsation Global Enable Setting.....	28
The Pulsation Type Setting.....	28
The Pulsation Output Invert Setting.....	29
The Pulsation Frequency Setting.....	29



Index Continued

- The Pulsation Ratio 1 Setting..... 30
- The Pulsation Ratio 2 Setting..... 30
- The Wash Pulsation Frequency Setting..... 31
- The Wash Pulsation Ratio 1 Setting..... 31
- The Wash Pulsation Ratio 2 Setting..... 32
- The Stimulation Settings Menu..... 33
 - The Stimulation Global Enable Setting..... 33
 - The Automatic Stimulation Enable Setting..... 33
 - The Automatic Stimulation Initial Delay Setting..... 34
 - The Stimulation Increment Interval Setting..... 34
 - The Stimulation Time Setting..... 35
 - The Stimulation Maximum Multiplier Setting..... 35
 - The Stimulation Pulsation Frequency Setting..... 36
 - The Stimulation Pulsation Ratio 1 Setting..... 36
 - The Stimulation Pulsation Ratio 2 Setting..... 37
- The Wash Settings Menu..... 38
 - The Automatic Idle Time Setting..... 38
 - The Wash Time Setting..... 38
 - The Start In Wash Setting..... 39
- The Dump Line Settings Menu..... 40
 - The Dump Line Enable Setting..... 40
 - The Milk Line Wash Time Setting..... 40
 - The Dump Line Wash Time Setting..... 41
- The Send to System Function..... 42
- The M2Bus IDS Menu..... 43
- The Auto Number Function..... 44
- The Diagnostics Menu..... 46
 - The Display Test..... 46
 - The Key Test..... 46
 - The Probe Test..... 47
 - The Output Test..... 47
 - The Input Test..... 48
- The Device Info Menu..... 48
- Using the CR35 Control..... 49
- The Milking Procedure..... 49



Index Continued

Method of Stimulation.....	50
Conductivity Level Indicators and Pull Off.....	51
Information about Milk Conductivity Measurement.....	51
Animal Data.....	52
Animal Warnings.....	52
Editing Animal Flags.....	52
Stall selection in Multi-Stall mode.....	53
The Washing Procedure.....	54
Monthly Routine Maintenance.....	55
Six Monthly Routine Maintenance.....	55
Yearly Routine Maintenance.....	55
Parlour Wash Down.....	55
Additional Items Required to Install ACR System.....	56



Manual Versions

Version 1.0 - October 2017.....FirstVersion of Manual (Software v3.20)



About the CR35 Milking Point Control

The CR35 Milking Point Control is one of the most useful additions to a milking parlour, allowing the operator to save time when milking by automating the cluster removal process.

The CR35 has been designed for swingover and multi-point parlours (where 1 milking unit serves 2/3 milking points). It can be connected to the Micro M5 via a communications bus allowing milking times and conductivity values to be stored against individual animals. Warning flags can also be set, acknowledged and removed from animals via the flag key.

The ATL CR35 comes with the added extra of monitoring the conductivity of the milk. A flashing warning is displayed if the milk's conductivity is above a user selectable warning level, or pull off if the conductivity is above a user selectable pull off level. This extra function allows for advanced monitoring of your animals health, in a simple easy to use unit.

The CR35 is also upgradable to a milk meter by adding the milk meter flask and an additional solenoid to control the dumping of the milk from the flask.

Features

- Simple numeric display of the milking time (minutes:seconds) and the milks conductivity (mS - millisiemens);
- 6 keys - automatic milking, manual milking, wash, left, right and warning flags;
- Simple, bright, graphical LCD display;
- 7 LED windows for auto milking, pulsation, ACR, milk flow, conductivity, data and dump line;
- 3 Normal milking modes (ACR, Manual and Timed);
- 3 Additional Manual milking modes (ACR disabled, Conductivity pull off disabled, ACR and conductivity pull off disabled);
- Accurate milk flow measurement for ACR removal;
- Full pulsation control - 30 to 180 pulses per minute (ppm) and 35% to 75% ratios;
- Pulsation stop - pulsator only on when milking or washing;
- Stimulation pulsation with 3 stimulation modes (Automatic, Manual and disabled);
- Washing pulsation - runs pulsation at lower rate during washing to reduce liner wear;
- Automatic idle after a user selectable period of inactivity;
- User programable wash time with wash time elapsed and remaining displayed (minutes:seconds);
- User selectable conductivity warning and pull off levels;
- User selectable ACR pull off milk flow rate and time;
- Lift to start ACR input;
- Milk sweep / purge;
- Suitable for all herd / flock sizes (small or large);
- M2 communications bus - enables all CR35 controls to be put into milk or wash from 1 control and animal data to be sent / received from Micro M5 parlour control. Data available:
 - Identifies slow milker and uses different ACR settings to prevent early removal;
 - Warns if colostrum or antibiotic milk;
 - Warns if previous conductivity lower than expected;
 - Warns if milking taking longer than expected;
 - Warns if conductivity higher than expected;
 - Warns if milking time shorter than expected;

Features Continued

- Warning flags can be set and acknowledged against each animal using the flag key;
- If using time-based cluster removal can change the milking time for all points from 1 milking point;
- Top up feed (TuF) allows operator to top up feed from milking point control;
- Dump line changeover.

Front Cover

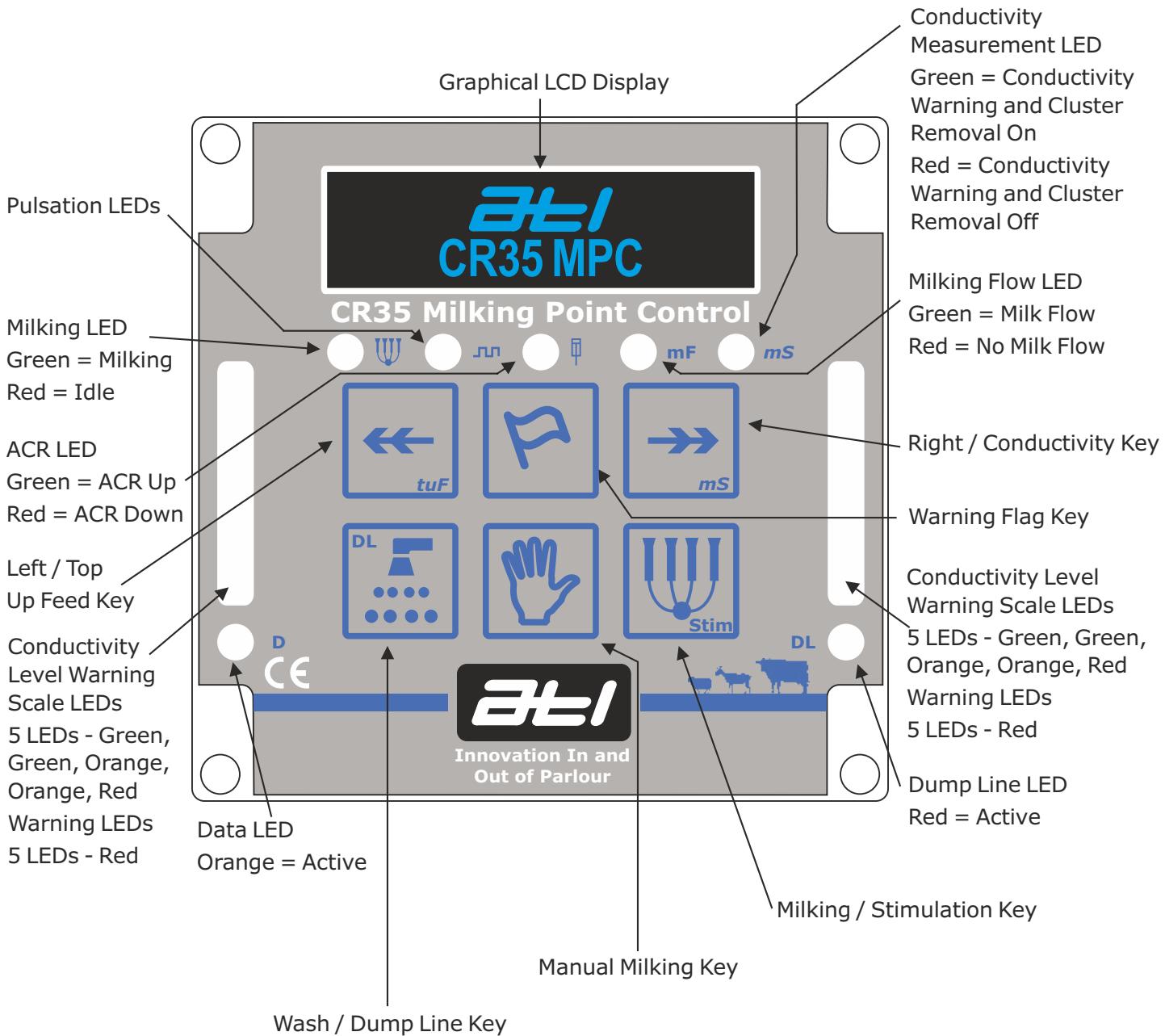

Installing the Sensor



The ACR sensor should be installed so that it is aligned correctly. The vertical alignment should match the picture shown above. If the sensor is not installed in this alignment, it will not function correctly.

Installing the Milking Point Control

The bracket can attach to either vertical or horizontal tubes. They are supplied with 2 off 45mm u-bolts as standard.

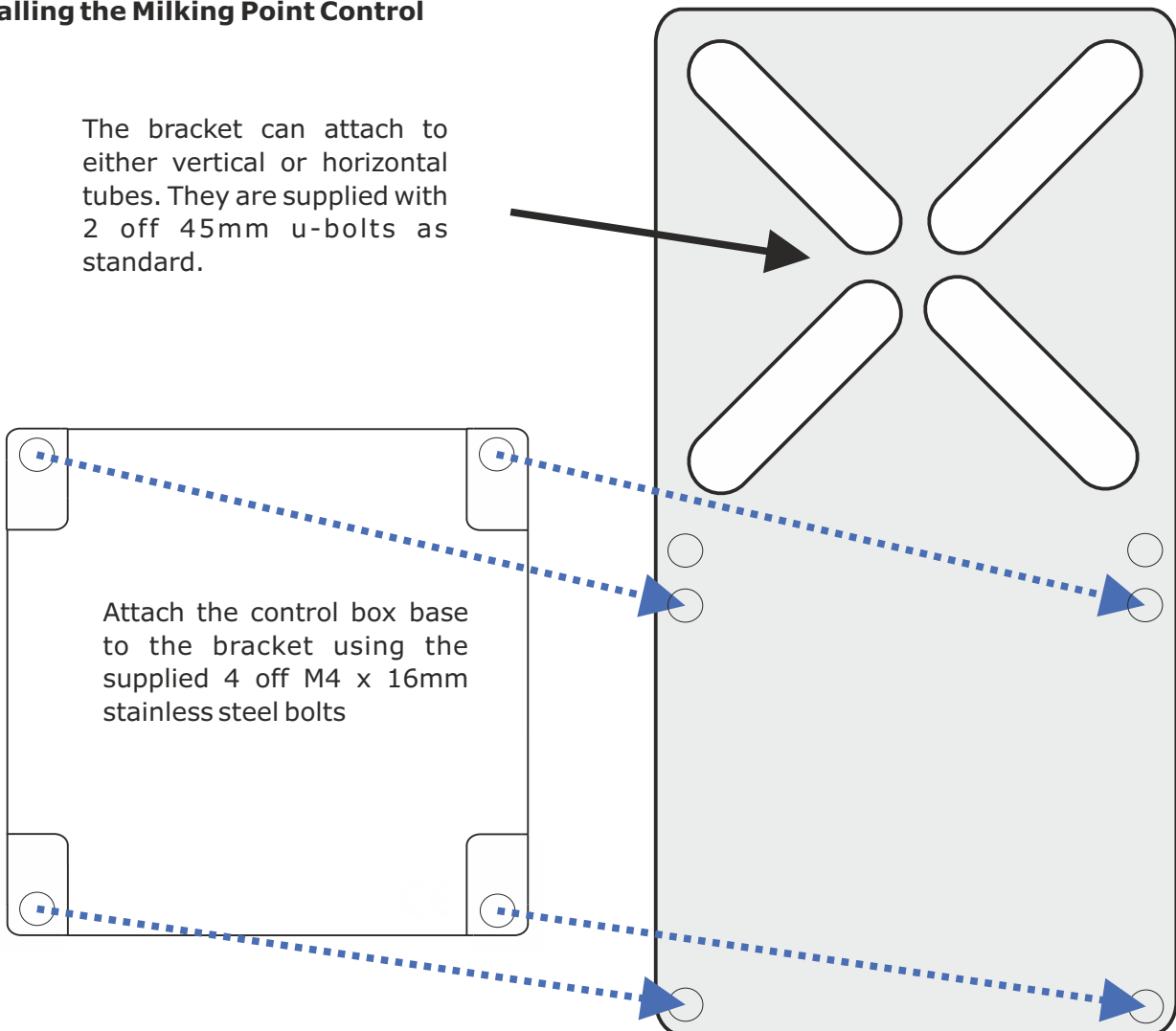

Milking Point Control Wiring Connections

The milking point control wiring connections are shown in the diagram and corresponding table below. The control comes with two 4 port glands. The 4 port gland can take a maximum cable OD of 6.5mm.

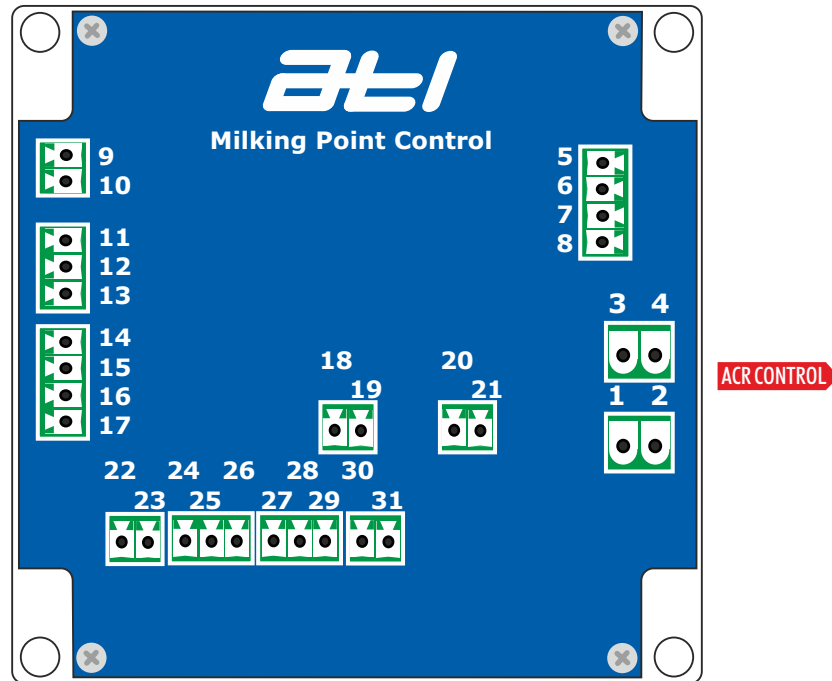

Number	Connects To	Cable Specification
1	Power In +12vDC	Minimum 1.0mm ² core 10A cable
2	Power In -12vDC	Minimum 1.0mm ² core 10A cable
3	Power Out +12vDC	Minimum 1.0mm ² core 10A cable
4	Power Out -12vDC	Minimum 1.0mm ² core 10A cable
5	ACR Sensor + / Meter Bottom Probe	Sensor Cable Blue / Probe Cable Red
6	Milk Meter Middle Probe	Probe Cable Green
7	ACR Sensor - / Meter Top Probe	Sensor Cable Black / Probe Cable White
8	Milk Meter Probe Screen	Probe Cable Screen
9	Auto Start Ram -	Factory Fitted to Auto Start Ram
10	Auto Start Ram +	Factory Fitted to Auto Start Ram
11	M2Bus In Screen	Twisted Pair Data Cable Screen
12	M2Bus In Data B	Twisted Pair Data Cable Black
13	M2Bus In Data A	Twisted Pair Data Cable Red
14	M2Bus Out Screen	Twisted Pair Data Cable Screen
15	M2Bus Out EOL Link	Only connect when instructed by ATL
16	M2Bus Out Data B	Twisted Pair Data Cable Black
17	M2Bus Out Data A	Twisted Pair Data Cable Red
18	Side Input +Ve Input	Minimum 0.5mm ² 0.5A cable
19	Side Input -Ve Input	Minimum 0.5mm ² 0.5A cable



Milking Point Control Wiring Connections Continued

Number	Connects To	Cable Specification
20	Side & Auto Start +Ve Supply	Minimum 0.5mm ² 0.5A cable
21	Side & Auto Start -Ve Supply	Minimum 0.5mm ² 0.5A cable
22	Meter Solenoid -12vDC	Factory Fitted to Control Valve
23	Meter Solenoid +12vDC	Factory Fitted to Control Valve
24	ACR Solenoid -12vDC	Factory Fitted to Control Valve
25	ACR & Shut Off Valve Solenoid +12vDC	Factory Fitted to Control Valve
26	Shut Off Valve Solenoid -12vDC	Factory Fitted to Control Valve
27	Pulsation Solenoid Channel 1 -12vDC	Factory Fitted to Control Valve
28	Pulsation Solenoids +12vDC	Factory Fitted to Control Valve
29	Pulsation Solenoid Channel 2 -12vDC	Factory Fitted to Control Valve
30	Dump Line Solenoid -12vDC	Minimum 0.5mm ² 0.5A cable
31	Dump Line Solenoid +12vDC	Minimum 0.5mm ² 0.5A cable

IMPORTANT - DO NOT INSTALL TWO CABLES THROUGH 1 CABLE HOLE IN THE 4 PORT GLAND. THIS WILL INVALID THE WARRANTY.

IMPORTANT - THE POWER OUT CONNECTIONS SHOULD NOT BE USED UNLESS ABSOLUTELY NECESSARY.



12vDC 396 Watt Power Supply Wiring Connections

- Mains Voltage: 100-240volt AC
- Output Voltage: Nominal 13.6volt DC
- Mains Fuse: 5 Amp
- Automatic Over Current Protection
- Maximum Number Of Milking Point Controls With ATL Control Valves: 60

Maximum Number Of Milking Point Controls With ATL Control Valves & Pulsation: 30

NB - Maximum number of ACR controls will depend upon ACR control valve solenoid specifications - if unsure please contact ATL.

- Ensure the loading on each power supply is as even as possible.
- Recommended ACR Solenoid Spec: 12 volt DC Continuous Operation Normally Closed with power rating up to 3 watts.
- Recommend system is powered on all of the time to prevent condensation build up on electronic components.

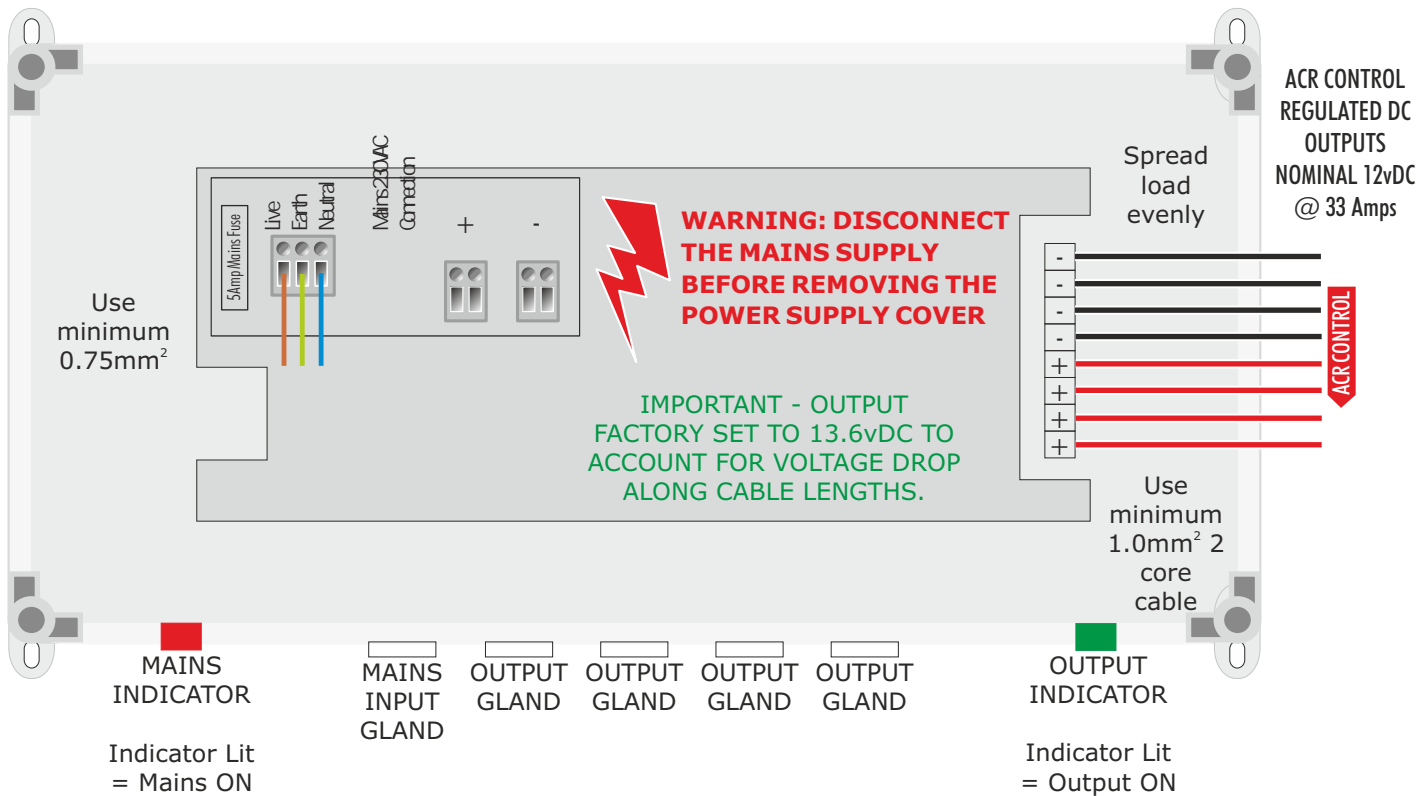

Connect to ACR controls.



Output Specification: Nominal 12vDC @ 33 Amps

IMPORTANT - Use different cable for each block of 10 MM controls to provide for current requirements of system. This is based upon using CV20 control valve with nominal 3 watts per solenoid coil. If using existing control valve, please check wattage and reduce numbers accordingly.

A 24vDC power supply can also be used Please make sure all solenoids are 24vDC.



System Wiring Overview

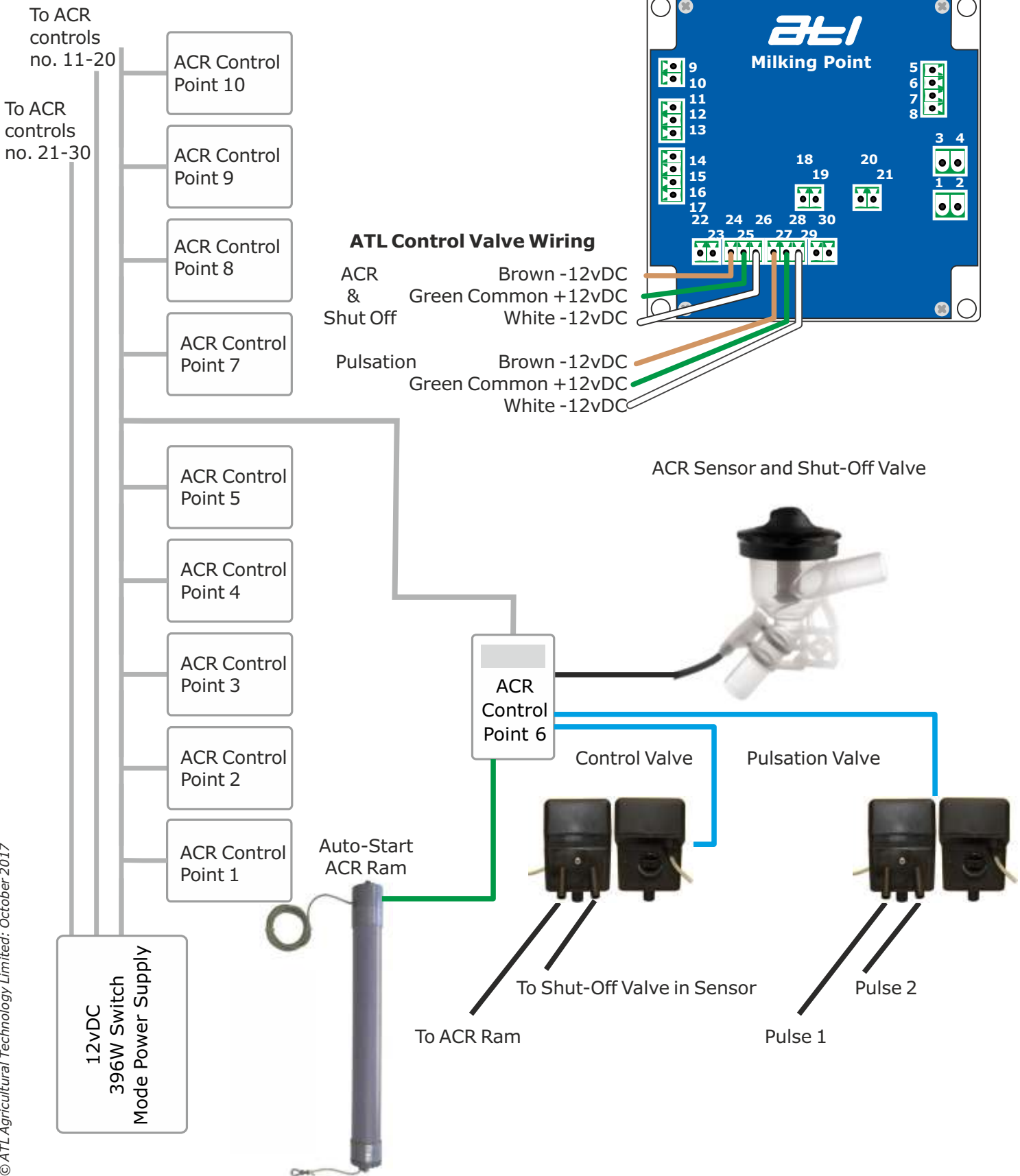

© ATL Agricultural Technology Limited: October 2017



Setting up the CR35 Milking Point Control

Before it can be used, the milking point control system must be setup. This is outlined in the following pages:

Accessing the Settings

Press and hold the Left and Manual keys together first and then press the Right key, whilst holding the Left and Manual keys.



The Setup Menu

The setup menu is divided into sections, each section deals with a specific part of the control. The sections can be stepped through using the Left and Right keys, and accessed using the Milk key.

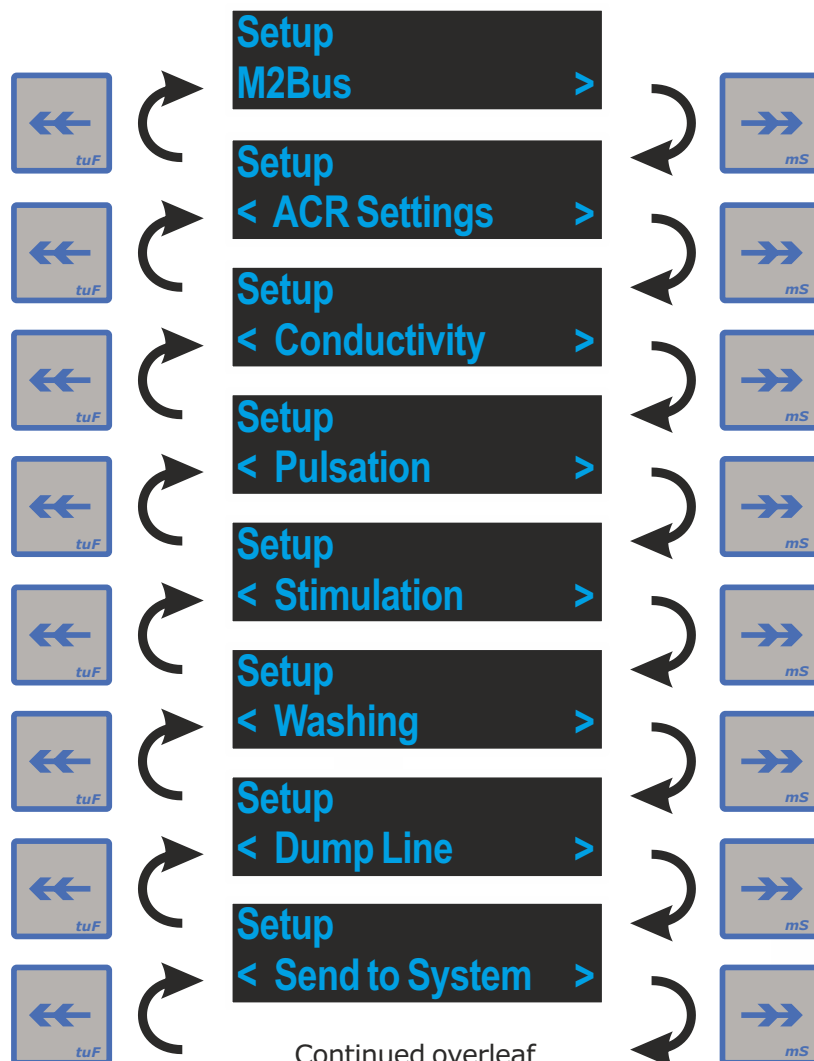



The Setup Menu Continued

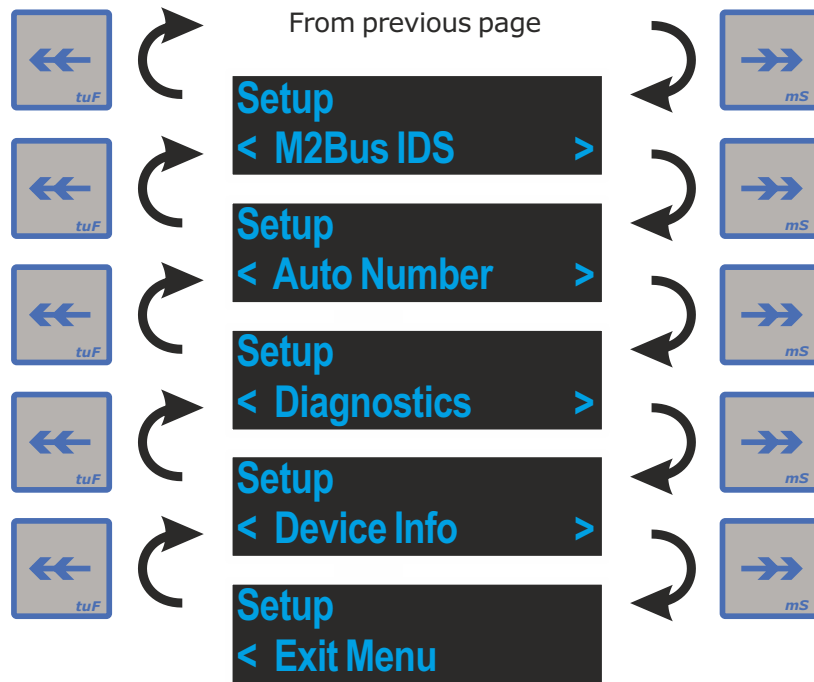

Pressing the Milk key when on a menu item will allow the user to edit the menu items in that item.



The M2Bus Menu

The M2Bus menu contains the settings controlling the meridian 2 communications bus. There are a number of settings, each listed in the following pages.

The Stall Number Setting

The Stall number setting is the unique control address. Each control must have a different number for the communications bus to function and data to be transferred correctly. The range is 1 to 255. The factory default is 1.

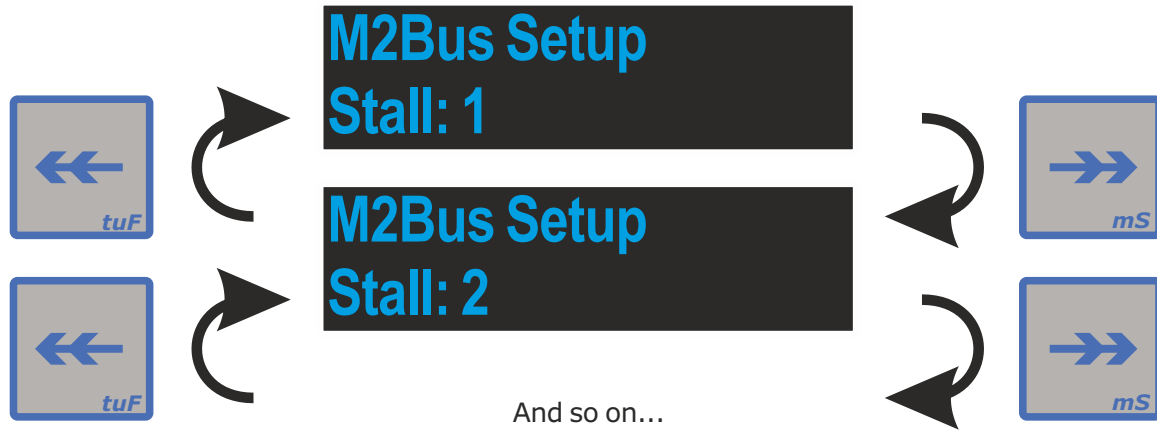

Press the Right key to increase the time

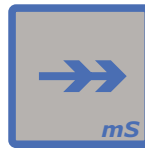

Hold the Right key to increase in 10s

Press the Left key to decrease the time



Hold the Left key to decrease in 10s

When the correct setting is selected, press the Milk key to store the data.
The next menu item is now displayed.





The Parlour Type Setting

This setting selects the type of parlour the milk meter control is being installed on - doubled up, rotary, multi-stall single sided, multi-stall double sided and swingover parlours. Multi-stall allows for parlours where one milking unit is shared between 2 or 3 animal standings - this is especially popular on goat and sheep parlours. The factory default is Side LHS.

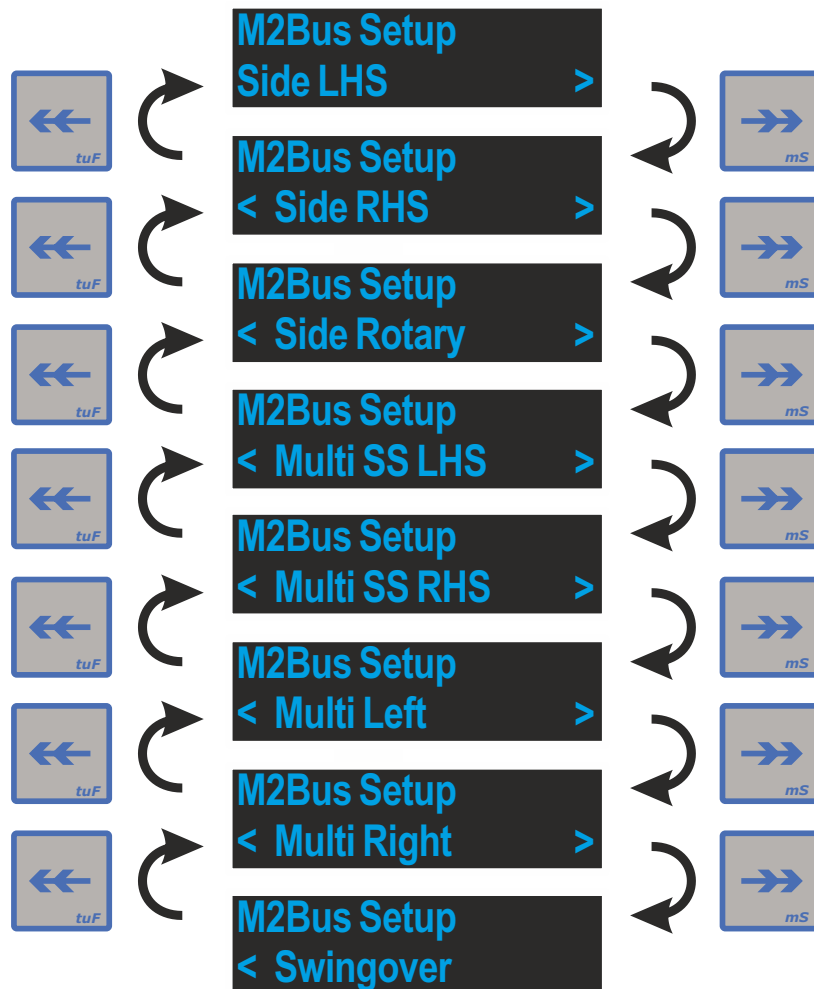

Pressing the Milk key will save the current setting. If the setting chosen is a multi stall one, the menu will display the width setting, otherwise it will return to the main setup menu.



The Stall Width Setting **(Visible only when the Side setting is one of the multi stall options)**

The side width setting allows the user to input the number of stalls the control will milk, the default is 2, the maximum is 3.

M2Bus Setup
Width: 2

Press the Right key to increase the time

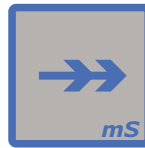

Press the Left key to decrease the time

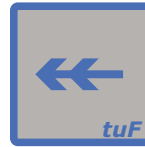

When the correct setting is selected, press the Milk key to store the data.



The control will return to the main menu.



The ACR Settings Menu

The ACR settings menu contains the settings for how the control will function as an ACR. There are a number of settings, each listed in the following pages;

The Animal Type Setting

The Animal Type setting selects the type of animal being milked using the control and changes the nomenclature displayed accordingly. Pressing the Right key will step through the available animal types, pressing the Left key will step back. Pressing the Milk key will save the animal type and move onto the next setting. The factory default is cows.



Pressing the Milk key will save the current setting and move onto the next menu item.



The ACR Mode Setting

The ACR Mode setting controls how the milking point control will function when milking an animal. There are three modes available, these are; ACR, Manual and Timed. Pressing the Right key will step through the available configurations, pressing the Left key will step back. Pressing the Milk key will save the setting and move onto the next setting.

ACR Mode - Uses the milk flow and automatically removes the milking unit when the flow rate drops below a certain flow (ml/minute or g/minute - milk meter - or resistance - cluster remover).

Manual Mode - Operator starts and stops the milking via pressing keys on the control unit. Milk flow rate is ignored throughout.

Timed Mode - Milking for preset length of time. Units can then be allowed to drop off (sheep/goats) or automatically removed using ACR cylinder. Flow rate is ignored throughout.

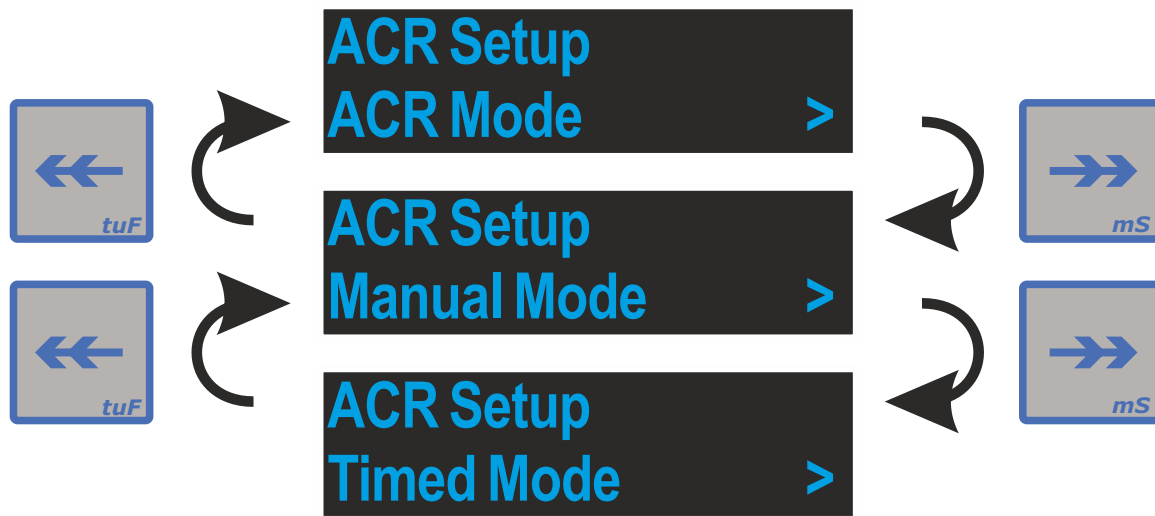

Pressing the Milk key will save the current setting and move onto the next menu item.

If the milking mode selected is ACR, the ACR hold off setting will be shown next.

If the milking mode selected is Manual, the vacuum delay setting will be shown next.

If the milking mode selected is Timed, the milking time setting will be shown next.



The ACR Hold Off Delay Setting (Visible only when the Milking Mode is ACR)

The ACR hold off setting lets the user specify the length of time before the ACR becomes active after the start of milking. The range is from 10 seconds to 240 seconds. The factory default is 120 seconds.



Press the Right key to increase the time

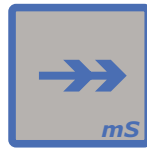

Hold the Right key to increase in 10s

Press the Left key to decrease the time

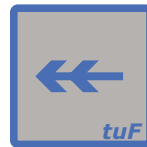

Hold the Left key to decrease in 10s

When the correct setting is selected, press the Milk key to store the data.



The kick off delay setting is now displayed.

The Kick Off Delay Setting (Visible only when the Milking Mode is ACR)

The kick off delay setting lets the user specify the length of time after the ACR hold off delay has passed, that if an ACR take off occurs, the control will give a kick off alert. The range is from 30 seconds to 999 seconds.

The factory default is 180 seconds.



Press the Right key to increase the time



Hold the Right key to increase in 10s

Press the Wash key to decrease the time



Hold the Left key to decrease in 10s

When the correct setting is selected, press the Milk key to store the data.



The ACR pull off resistance setting is now displayed.



The ACR Pull Off Timer Setting (Visible only when the Milking Mode is ACR)

The ACR pull off timer setting lets the user specify the length of time the resistance must be above the ACR pull off resistance setting before the ACR is activated. The range is from 1 second to 30 seconds.

The factory default is 6 seconds.



Press the Conductivity key to increase the time



Hold the Conductivity key to increase in 10s

Press the Wash key to decrease the time



Hold the Wash key to decrease in 10s

When the correct setting is selected, press the Milk key to store the data.



The ACR pull off resistance function is now displayed.

The ACR Pull Off Resistance Setting (Visible only when the Milking Mode is ACR)

The ACR pull off resistance setting lets the user specify the maximum resistance that the milk is allowed to be before the ACR pull off timer is activated. If the resistance goes above the value and then falls back below, the ACR pull off timer is reset. The range is from 25 ohms to 999 ohms. The factory default is 750 ohms.



Press the Conductivity key to increase the value



Hold the Conductivity key to increase in 10s

Press the Wash key to decrease the value



Hold the Wash key to decrease in 10s

When the correct setting is selected, press the Milk key to store the data.



The vacuum delay function is now displayed.



The Milking Time Setting (**Visible only when the Milking Mode is Timed**)

The milking time setting lets the user specify the length of time the animal will be milking for in timed mode. The range is 10 seconds to 900 seconds. The factory default is 180 seconds.

ACR Setup
Time: 180 Sec

Press the Conductivity key to increase the time



Hold the Conductivity key to increase in 10s

Press the Wash key to decrease the time



Hold the Wash key to decrease in 10s

When the correct setting is selected, press the Milk key to store the data.



The vacuum delay setting is now displayed.



The Vacuum Delay Setting

The vacuum delay setting allows the user to set a delay between the operation of the shut-off valve closing to shut off the vacuum and the ACR ram operating. It should be set to a value that ensures that as the shut-off valve operates at the end of milking, the vacuum delays to a point where the cluster is just about to fall before the ACR ram operates. The range is from 1 second to 10 seconds. The factory default is 3 seconds.

ACR Setup
Vac Delay: 3 Sec

Press the Right key to increase the time

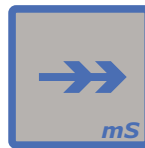

Hold the Right key to increase in 10s

Press the Left key to decrease the time



Hold the Left key to decrease in 10s

When the correct setting is selected, press the Milk key to store the data.



The purge function is now displayed.

The Purge Setting

The purge setting is a YES / NO setting. When the ACR ram operates, setting the purge to YES makes the shut-off valve momentarily open to purge any milk residues into the milk line. The factory default is YES.

ACR Setup Purge
Enable: Yes

Press the Right key to enable the setting.

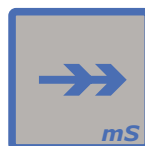

Press the Left key to disable the setting.



When the correct setting is selected, press the Milk key to store the data.



If the purge setting is enabled, the purge hold off function is now displayed, otherwise, the ACR settings main menu is displayed.



The Purge Hold Off Setting **(Visible only when the Purge is Yes)**

It allows a delay to be set between the ACR operating and the purge activating. It is for installations with flushing systems. The range is from 1 seconds to 60 seconds. The factory default is 1 second.

ACR Setup Purge Hold Off: 1 Sec

Press the Right key to increase the time

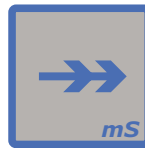

Hold the Right key to increase in 10s

Press the Left key to decrease the time

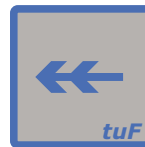

Hold the Left key to decrease in 10s

When the correct setting is selected, press the Milk key to store the data.



The start input is edge function is now displayed.

The Start Input Is Edge Setting

The start input is edge setting is a YES / NO setting. This setting selects between the start input being a pulse (low to high - YES) or an edge trigger (NO). The factory default is NO .

ACR Start Input is Edge: No

Press the Right key to enable the setting.



Press the Left key to disable the setting.



When the correct setting is selected, press the Milk key to store the data.



The ACR Swing to Start menu is now displayed.



The ACR Swing to Start Setting (**Visible only when the Side setting is Swing Over**)

This setting enables to meter to start automatically when the swingarm is swung to change sides. It requires a swingover switch to function and can be used on both stand-alone and systems connected to a Micro. The factory default is NO.

ACR Swing to Start: No

Press the Right key to enable the setting.

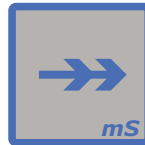

Press the Left key to disable the setting.



When the correct setting is selected, press the Milk key to store the data.

The ACR main menu item is now display.





The Conductivity Settings Menu

The Conductivity settings menu contains the settings for how the conductivity functions on the control will function. There are 3 settings, each listed in the following pages;

The Conductivity Global Enable Setting

The conductivity global enable setting is a YES / NO setting, this setting enables or disables the conductivity features of the control. The factory default is YES.

**Conductivity
Enable: Yes**

Press the Right key to enable the setting.

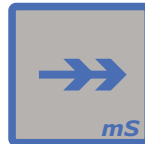

Press the Left key to diable the setting.



When the correct setting is selected, press the Milk key to store the data.



If conductivity is enabled the conductivity warning level function is now displayed, otherwise the conductivity main menu item is displayed.

The Conductivity Warning Level Setting **(Visible only when the Conductivity is Yes)**

The conductivity warning level setting is the conductivity level whereby the conductivity warning scale LEDs will flash . The range is from 2 millisiemens to 20 millisiemens. The factory default is 5.5 millisiemens.

**Conductivity
Warning: 5.50 mS**

Press the Right key to increase the value in tenths



Hold the Right key to increase in whole units.

Press the Left key to decrease the value in tenths



Hold the Left key to decrease in whole units.

When the correct setting is selected, press the Milk key to store the data.

The conductivity pull off function is now displayed.





The Conductivity Pull Off Level Setting (**Visible only when the Conductivity is Yes**)

The conductivity pull off level setting allows the user to set the conductivity level at which the ACR activates and the cluster is removed from the animal. The range is from 2 millisiemens to 20 millisiemens. The factory default is 6 millisiemens.

**Conductivity
Remove: 6.00 mS**

Press the Right key to increase the value in tenths

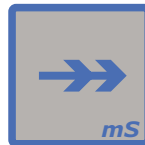

Hold the Right key to increase in whole units.

Press the Left key to decrease the value in tenths



Hold the Left key to decrease in whole units.

When the correct setting is selected, press the Milk key to store the data.

The conductivity main menu item is now displayed.





The Pulsation Settings Menu

The Pulsation settings menu contains the settings for how the pulsation outputs function on the control. There are a number of settings, each listed in the following pages.

The Pulsation Global Enable Setting

The pulsation global enable setting is a YES / NO setting, this setting enables or disables the pulsation features of the control. The factory default is YES.



Press the Right key to enable the setting.

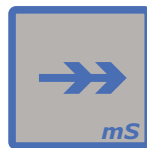

Press the Left key to disable the setting.

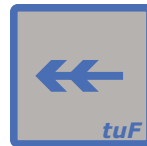

When the correct setting is selected, press the Milk key to store the data.

If pulsation is enabled, the pulsation type function is now displayed, otherwise the pulsation main menu item is displayed.

The Pulsation Type Setting (Visible only when Pulsation is Yes)

The pulsation type setting allows the control to be set to alternate or simultaneous pulsation. The factory default is alternate. Press either the Right or Left keys to toggle between the two modes.

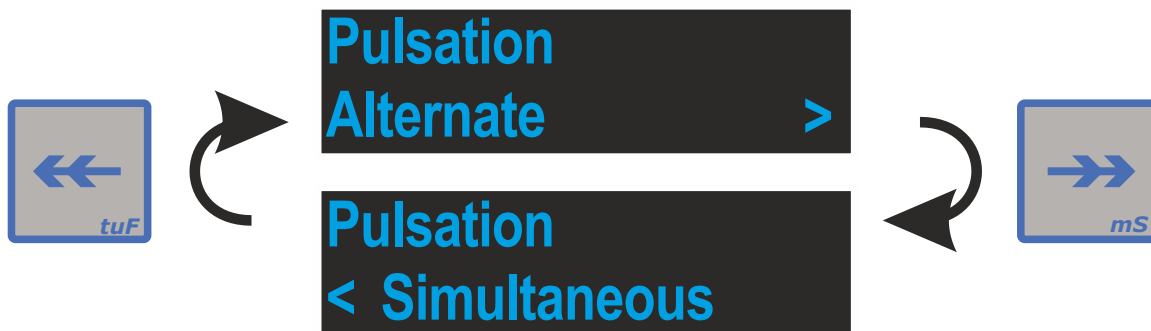

When the correct setting is selected, press the Milk key to store the data.

The pulsation output invert function is now displayed.





The Pulsation Output Invert Setting (**Visible only when Pulsation is Yes**)

The pulsation output invert setting is a YES / NO setting. This setting will invert the outputs for pulsators which function in reverse. The factory default is NO.

**Pulsation
Invert: No**

Press the Right key to enable the setting.

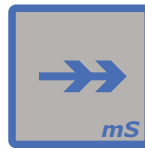

Press the Left key to disable the setting.

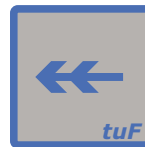

When the correct setting is selected, press the Milk key to store the data.
The pulsation frequency function is now displayed.



The Pulsation Frequency Setting (**Visible only when Pulsation is Yes**)

The pulsation frequency setting controls the frequency of the pulsation during milking. The range is 30 to 180 pulses per minute. The factory default is 60 pulses per minute.

**Pulsation
Freq: 60 PPM**

Press the Right key to increase the value



Hold the Right key to increase in 10s

Press the Left key to decrease the value



Hold the Left key to decrease in 10s

When the correct setting is selected, press the Milk key to store the data.
The pulsation ratio fo channel 1 is now displayed.





The Pulsation Ratio 1 Setting (Visible only when Pulsation is Yes)

The pulsation ratio 1 setting controls the ratio of channel 1's on time as a percentage of the total time. The factory default is 60 percent on.

**Pulsation
Ratio 1: 60**

Press the Right key to increase the time

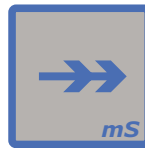

Hold the Right key to increase in 10s

Press the Left key to decrease the time

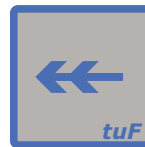

Hold the Left key to decrease in 10s

When the correct setting is selected, press the Milk key to store the data.
The pulsation ratio for channel 2 is now displayed.



The Pulsation Ratio 2 Setting (Visible only when Pulsation is Yes)

The pulsation ratio 2 setting controls the ratio of channel 2's on time as a percentage of the total time. The factory default is 60 percent on.

**Pulsation
Ratio 2: 60**

Press the Right key to increase the time



Hold the Right key to increase in 10s

Press the Left key to decrease the time



Hold the Left key to decrease in 10s

When the correct setting is selected, press the Milk key to store the data.
The wash pulsation frequency is now displayed.





The Wash Pulsation Frequency Setting **(Visible only when Pulsation is Yes)**

The wash pulsation frequency setting controls the frequency of the pulsation during washing. The factory default is 60 pulses per minute.

**Wash Pulsation
Freq: 60 PPM**

Press the Right key to increase the value

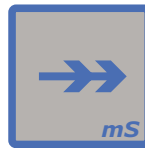

Hold the Right key to increase in 10s

Press the Left key to decrease the value

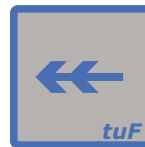

Hold the Left key to decrease in 10s

When the correct setting is selected, press the Milk key to store the data.
The wash pulsation channel 1 ratio is now displayed.



The Wash Pulsation Ratio 1 Setting **(Visible only when Pulsation is Yes)**

The wash pulsation ratio 1 setting controls the ratio of channel 1's on time as a percentage of the total time when washing. The factory default is 60 percent on.

**Wash Pulsation
Ratio 1: 60**

Press the Right key to increase the time



Hold the Right key to increase in 10s

Press the Left key to decrease the time



Hold the Left key to decrease in 10s

When the correct setting is selected, press the Milk key to store the data.
The wash pulsation channel 2 ratio is now displayed.





The Wash Pulsation Ratio 2 Setting **(Visible only when Pulsation is Yes)**

The wash pulsation ratio 2 setting controls the ratio of channel 2's on time as a percentage of the total time during washing. The factory default is 60 percent on.

Wash Pulsation Ratio 2: 60

Press the Right key to increase the time



Hold the Right key to increase in 10s

Press the Left key to decrease the time



Hold the Left key to decrease in 10s

When the correct setting is selected, press the Milk key to store the data.
The pulsation main menu item is now displayed.



The Stimulation Settings Menu

The Stimulation settings menu contains the settings for the stimulation function on the control. There are a number of settings, each listed in the following pages.

The Stimulation Global Enable Setting

The stimulation global enable setting is a YES / NO setting, this setting enables or disables the stimulation features of the control. The factory default is YES.

**Stimulation
Enable: Yes**

Press the Right key to enable the setting.

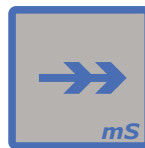

Press the Left key to disable the setting.

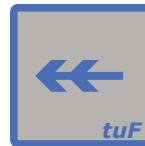

When the correct setting is selected, press the Milk key to store the data.

If stimulation is enabled, the automatic stimulation setting is now displayed, otherwise, the stimulation main menu item is displayed.

The Automatic Stimulation Enable Setting (Visible only when Stimulation is Yes)

The automatic stimulation enable setting is a YES / NO setting, this setting enables or disables the automatic stimulation function of the control. The factory default is NO.

**Stimulation
Auto: No**

Press the Right key to enable the setting.



Press the Left key to disable the setting.



When the correct setting is selected, press the Milk key to store the data.

The automatic stimulation initial delay function is now displayed.



The Automatic Stimulation Initial Delay Setting **(Visible only when Stimulation is Yes)**

The automatic stimulation initial delay setting controls the delay before stimulating the animal to produce milk. The factory default is 20 seconds.

**Stimulation
Delay: 20 Sec**

Press the Right key to increase the time

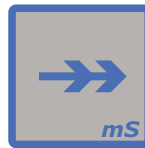

Hold the Right key to increase in 10s

Press the Left key to decrease the time

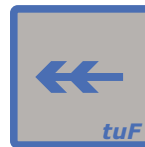

Hold the Left key to decrease in 10s

When the correct setting is selected, press the Milk key to store the data.

The stimulation increment interval is now displayed.



The Stimulation Increment Interval Setting **(Visible only when Stimulation is Yes)**

The stimulation increment interval setting controls the time taken to increase the normal milking pulsation frequency and ratios to the stimulation frequency and ratios. The factory default is 5 seconds.

**Stimulation
Inc: 5 Sec**

Press the Right key to increase the time



Hold the Right key to increase in 10s

Press the Left key to decrease the time



Hold the Left key to decrease in 10s

When the correct setting is selected, press the Milk key to store the data.

The stimulation time setting is now displayed.





The Stimulation Time Setting (Visible only when Stimulation is Yes)

The stimulation time setting controls the length of stimulation for the animal. The factory default is 15 seconds.

**Stimulation
Inc Time: 15 Sec**

Press the Right key to increase the time

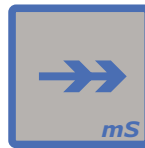

Hold the Right key to increase in 10

Press the Left key to decrease the time

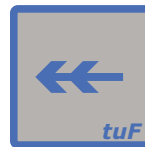

Hold the Left key to decrease in 10s

When the correct setting is selected, press the Milk key to store the data.

The stimulation maximum multiplier is now displayed.



The Stimulation Maximum Multiplier Setting (Visible only when Stimulation is Yes)

The stimulation maximum multiplier setting controls maximum length of stimulation when the user lengthens the stimulation manually by holding the milk key when stimulation is enabled, for example if this is 6, the maximum time stimulation can occur for is 6 times the stimulation time. The factory default is 6.

**Stimulation
Multiplier: 6**

Press the Right key to increase the time



Hold the Right key to increase in 10

Press the Left key to decrease the time



Hold the Left key to decrease in 10s

When the correct setting is selected, press the Milk key to store the data.

The stimulation frequency is now displayed.





The Stimulation Pulsation Frequency Setting (Visible only when Stimulation is Yes)

The stimulation pulsation frequency setting controls the frequency of the pulsation during the stimulation of the animal. The factory default is 60 pulses per minute. This cannot be lower than the pulsation frequency.

**Stimulation
Freq: 60 PPM**

Press the Right key to increase the value

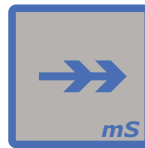

Hold the Right key to increase in 10s

Press the Left key to decrease the value

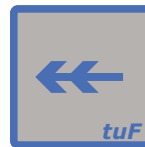

Hold the Left key to decrease in 10s

When the correct setting is selected, press the Milk key to store the data.
The stimulation pulsation ratio 1 is now displayed.



The Stimulation Pulsation Ratio 1 Setting (Visible only when Stimulation is Yes)

The stimulation pulsation ratio 1 setting controls the ratio of channel 1's on time as a percentage of the total time when stimulating. The factory default is 60 percent on.

**Stimulation
Ratio 1: 60**

Press the Right key to increase the time



Hold the Right key to increase in 10s

Press the Left key to decrease the time



Hold the Left key to decrease in 10s

When the correct setting is selected, press the Milk key to store the data.
The stimulation pulsation ratio 2 is now displayed.





The Stimulation Pulsation Ratio 2 Setting **(Visible only when Stimulation is Yes)**

The stimulation pulsation ratio 2 setting controls the ratio of channel 2's on time as a percentage of the total time during stimulation. The factory default is 60 percent on.

**Stimulation
Ratio 2: 60**

Press the Right key to increase the time

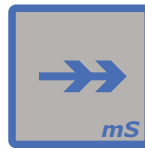

Hold the Right key to increase in 10s

Press the Left key to decrease the time

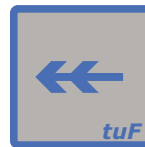

Hold the Left key to decrease in 10s

When the correct setting is selected, press the Milk key to store the data.

The stimulation main menu item is now displayed.





The Wash Settings Menu

The Wash settings menu contains the settings for the wash function on the control. There are 3 settings, each listed in the following pages;

The Automatic Idle Time Setting

The automatic idle time setting controls how long the milking point control will hold outputs on after no input is received from the user, this allows the system to turn off unwanted outputs when the parlour is not running, thus saving energy. The range is 5 to 360 minutes. The factory default is 15 minutes.

Wash Setup
Idle Delay: 15 Min

Press the Right key to increase the time

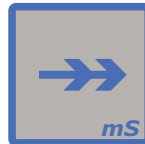

Hold the Right key to increase in 10s

Press the Left key to decrease the time

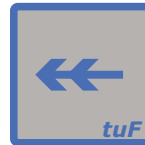

Hold the Left key to decrease in 10s

When the correct setting is selected, press the Milk key to store the data.
The wash time setting is now displayed.



The Wash Time Setting

The wash time setting controls how long the milking point control will run its wash routine before switching to idle. The range is 1 to 720 minutes. The factory default is 30 minutes.

Wash Setup
Time: 30 Min

Press the Right key to increase the time



Hold the Right key to increase in 10s

Press the Left key to decrease the time



Hold the Left key to decrease in 10s

When the correct setting is selected, press the Milk key to store the data.
The wash water resistance setting is now displayed.





The Start In Wash Setting

The start in wash setting is a YES / NO setting, this setting enables or disables the control to start in wash when the control first power's up, this allows automatic plant washers to wash the system automatically, the user is then able to take the system out of wash to milk. The factory default is NO.

Wash Setup

Start in Wash: No

Press the Right key to enable the setting.

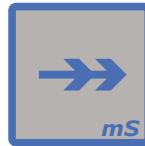

Press the Left key to disable the setting.



When the correct setting is selected, press the Milk key to store the data.
The wash main menu item is now displayed.





The Dump Line Settings Menu

The Dump Line settings menu contains the settings for the dump line function on the control. There are a number of settings, each listed in the following pages.

The Dump Line Enable Setting

The dump line enable setting is a YES / NO setting, this setting enables or disables the dump line features of the control. The factory default is YES.

**Dump Line
Enable: Yes**

Press the Right key to enable the setting.

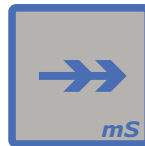

Press the Left key to disable the setting.



When the correct setting is selected, press the Milk key to store the data.

If dump line is enabled, the milk line wash time setting is now displayed, otherwise, the dump line main menu item is displayed.

The Milk Line Wash Time Setting (Visible only when Dump Line is Yes)

The milk line wash time setting controls how long the milk meter is connected to the milk line in seconds during the wash cycle. The range is 5 to 120 seconds. The factory default is 20 seconds.

**Dump Line
Milk Line: 20 Sec**

Press the Right key to increase the time



Hold the Right key to increase in 10.

Press the Left key to decrease the time



Hold the Left key to decrease in 10s

When the correct setting is selected, press the Milk key to store the data.

The dump line wash time is now displayed.





The Dump Line Wash Time Setting **(Visible only when Dump Line is Yes)**

The milk line wash time setting controls how long the milk meter is connected to the dump line in seconds during the wash cycle. The range is 5 to 120 seconds. The factory default is 10 seconds.

Dump Line
Dump Line: 10 Sec

Press the Right key to increase the time



Hold the Right key to increase in 10

Press the Left key to decrease the time

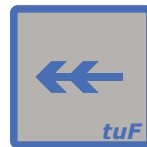

Hold the Left key to decrease in 10s

When the correct setting is selected, press the Milk key to store the data.
The dump line main menu item is now displayed.





The Send to System Setting

The Send to System settings menu allows the settings entered into one control to be sent to all the milking point controls on the system via the communications bus. Select the number of controls on the system. The range is 1 to 255. The factory default is 1.

**Send to System
Stalls: 1**

Press the Right key to increase



Hold the Right key to increase in 10

Press the Left key to decrease



Hold the Left key to decrease in 10s

When the correct number of controls has been selected, press the Milk key to send the settings to the controls.



**Transmit Settings
Error unit: 2**

If the settings cannot be sent to a control, an error will be reported as shown above.

**Transmit Settings
Update Finished**

If sending the settings is successful, the screen will show 'Update Finished'.

Press the Milk key to return to the main menu.





The M2Bus IDS Menu

The M2Bus IDS menu allows the user to check the communications bus is working correctly, there are a number of menu items:

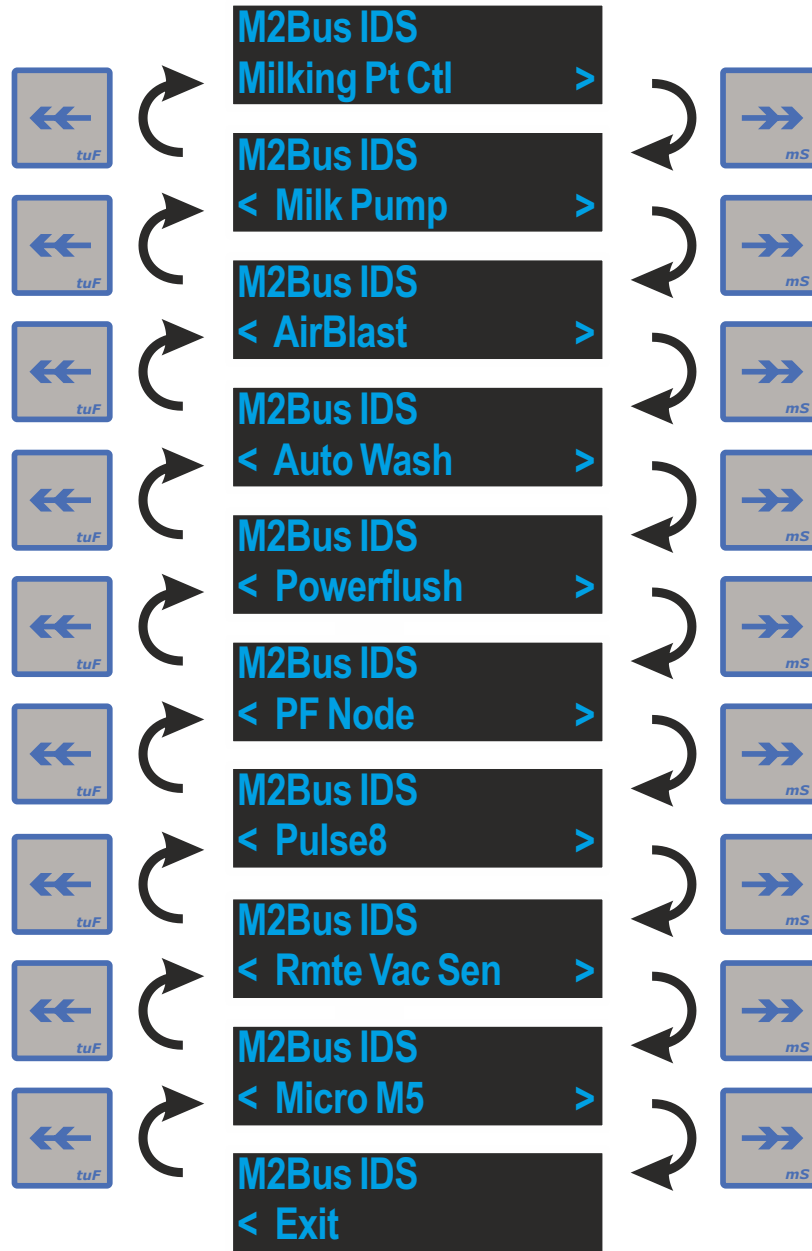

Pressing the Milk key when on a menu item will allow the user to check the communications to that item and to exit back to the main menu.

MPC IDS 1
Ok - Soft VX.XX

or

MPC IDS 2
Error - No Reply

Press the Milk key to exit back to the M2Bus IDS menu.

The Auto Number Setting

This setting allows milking point controls that are on the communications bus to be simply allocated their stall numbers, saving setup time. First select the type of parlour the milk meter control is being installed on - doubled up, rotary, multi-stall single sided, multi-stall double sided, swingover parlours and width if selecting a multi-stall configuration.

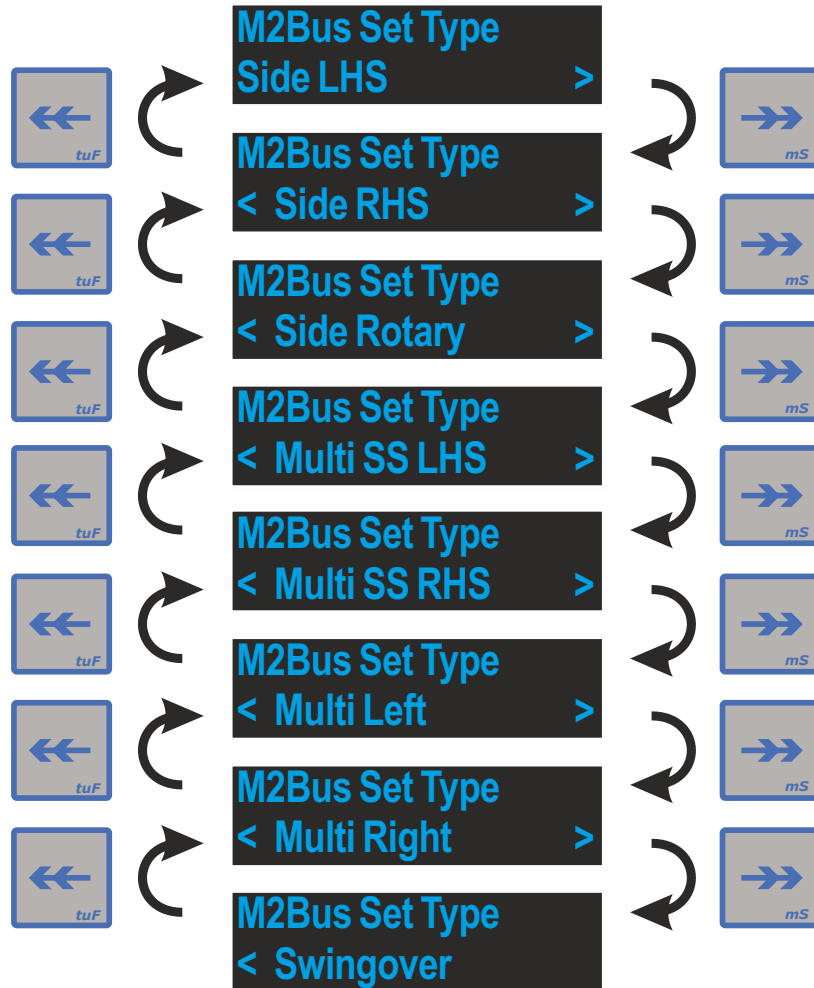

Pressing the Milk key will place all controls on the communications bus into Auto Number mode, or, if selecting a multi-stall configuration the width setting will show.

The Stall Width Setting (Visible only when the Side setting is one of the multi stall options)

The side width setting allows the user to input the number of stalls the control will milk, the default is 2, the maximum is 3.

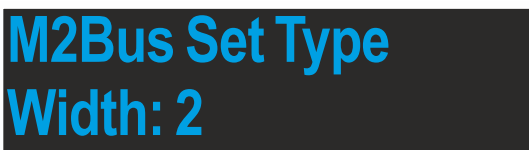

When the correct setting is selected, press the Milk key to start the auto numbering routine.



The Auto Number Routine

The basic method of operation of this routine is to allow the user to press a single key to identify a device as a stall number, allowing for the fast numbering of a parlour to occur simply by walking past all meters a pressing one key on each.

When the auto numbering mode is activated the screen will alternate between 'Auto Number' and the stall number i.e. 1L for stall 1 on the left hand side, for multi stall single sided parlours the side letter is not shown.

Auto Number

and

1L



Pressing the right arrow will store the current stall number on the device and begin searching for the next stall number.



Pressing the left arrow will allow the user to undo an incorrect stall number identification and redo it with the correct one.



Press the Milk key to exit the routine.



The Diagnostics Menu

The diagnostics menu allows the user to diagnose issues with the control, there are a number of menu items:

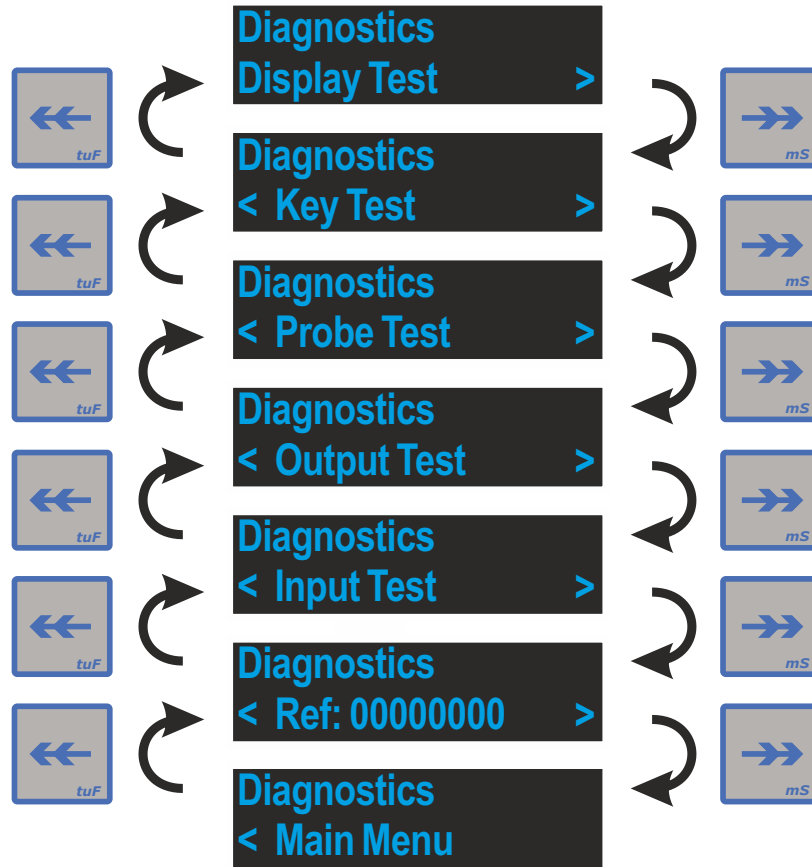

Pressing the Milk key when on a menu item will allow the user to access that item.

The Display Test Diagnostics Menu Item

The Display Test will turn on all pixels on the display, pressing the Milk key will return to the diagnostics menu.

The Key Test Diagnostics Menu Item

The Key Test menu item allows the testing of the keys, it will show the name of the key which has been pressed, pressing the Milk key will return to the diagnostics menu.



NB - The manual key is labelled ACR.



The Probe Test Diagnostics Menu Item

The Probe Test menu item will show the current value in milli-siemens of the probe, this allows the user to check the probe input is working correctly.

Probe Test
Bottom: 0.11mS

Press the Right key to select the top probe.



Press the Wash key to select the bottom probe.

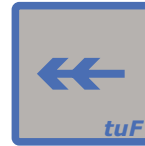

Press the Milk key to return to the diagnostics menu.



The Output Test Diagnostics Menu Item

The output test menu item allows the user to turn on and off all outputs on the control for testing.

ACR >
State: Off

Press the Right key to step to the next output.



Press the Wash key to step to the previous output.



Press the Milk key to toggle the output.



To exit the output test routine, scroll to the end using the Conductivity key and press the Milk key when on the Main Menu item.



The Input Test Diagnostics Menu Item

The Input Test menu item shows the state of the start input on the control.



Press the Milk key to return to the diagnostics menu.



The Device Info Menu

The device info menu allows the user to view information about the software in the control;

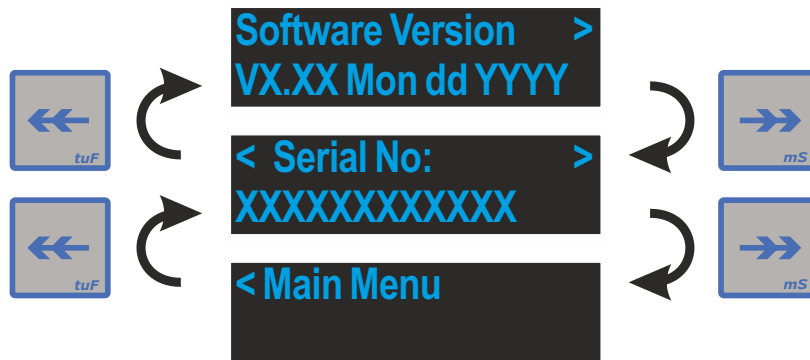

The software version menu item will show the version of the software as well as the build date.

The serial number will show the serial number of this control.

Press the Milk key  when < Main Menu displayed to exit.



Using the CR35 Control

The ACR control has 6 main milking modes - these are:

1. Automatic ACR removal and conductivity enabled;
2. Automatic ACR removal and conductivity disabled;
3. Manual ACR removal and conductivity enabled;
4. Manual ACR removal and conductivity disabled;
5. Timed Milking and conductivity enabled;
6. Timed Milking and conductivity disabled;

Automatic ACR removal allows the user to start the milking process and the ACR control completes it (i.e. the ACR ram removes the clusters from the animal and the milking is finished without user intervention).

Manual ACR removal allows the user to control the whole milking process from cluster attachment to removal.

Timed Milking allows the user to milk an animal for a specific time, then have the ACR remove the clusters from the animal.

The Milking Procedure

- Press the milking key to start milking in automatic mode or if in swing over mode, swing the arm, or if lift-to-start is connected, lift the cluster;
- The LCD display will show the milk conductivity on the right hand side and the milking mode on the top left. The animal number and milking time alternate in the bottom left of the LCD display;
- The status LEDs will show the respective states (milking will be green, pulsation will be running, ACR will be red, milk flow will indicate when milk is detected and conductivity will be green);
- The milking will continue until the ACR removes the cluster in ACR Mode, the time has elapsed in Timed mode or the Milk button is pressed in Manual mode, EXCEPT if the conductivity of the milk exceeds the conductivity pull off level whereby the cluster will be removed from the animal;
- If the animal is a slow milker or the cluster is removed early, press the manual key to restart milking.

Milking / Manual /
Idle State

The LCD display shows the word 'Milking' in large blue letters at the top. Below it, 'N: 123456' is displayed in blue, and '0.00ms' is displayed in blue on the right side.

Milk
Conductivity

Bottom quarter displays the following:
Animal Number (If available, Tag Error or No
Animal if not), Milking Time, Stimulation
State



Method of Stimulation

The CR35 Milking Point Control can provide the animal with stimulation when milk flow is not detected, or when the user decides to apply stimulation.

When automatically stimulating the control will wait the stimulation delay, if milk is not detected within this time, the control will start to ramp up the pulsation frequency until it matches the stimulation pulsation frequency, it will also alter the pulsation ratios.

When stimulating the control will show "Stim: XX:XX" on the display in the bottom left hand side where the milking status information is shown, where XX:XX will show the stimulation time left.

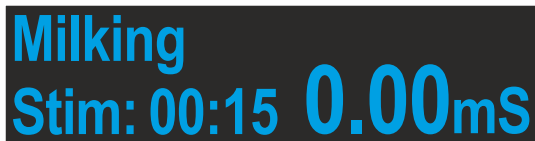

Milking
Stim: 00:15 0.00ms

The pulsation frequency and ratios will be ramped up to their stimulation settings using the interval delay to delay between changes.

Once milk is detected on the bottom probe of the milk meter, the control will begin to ramp down the pulsation frequency and ratios.

The user may start manually stimulating the animal at any time by pressing and holding the milking button.

The max multiplier setting is used when the user presses the stimulate button, this allows a maximum stimulation time to be set, and allows the user to cancel the stimulation by pressing the stimulation button until the control returns to normal milking mode.



Conductivity Warning Level Indicators and Pull Off

■ The conductivity level is shown in two ways:

1. The highest conductivity level in millisiemens recorded during the animals milking is shown on the LCD display;
2. The conductivity level warning scale LEDs give a visual indication of the conductivity of the milk of the animal. If the conductivity level is less than or equal to the conductivity warning level, 3 combinations of LEDs display dependent upon the conductivity level. These are:
 - 2.1 - 1 green LED - conductivity level less than or equal to 1/3 of conductivity warning level;
 - 2.2 - 2 green LEDs - conductivity level less than or equal to 2/3 of conductivity warning level;
 - 2.3 - 2 green LEDs and 1 yellow LED - conductivity level between 2/3 of conductivity warning level and conductivity warning level;

■ If the conductivity level is above the conductivity warning level but below the conductivity pull off level, 2 green LEDs and 2 yellow LEDs flash on the conductivity level warning scale LEDs. Further investigation of the animal is required to ascertain whether there is mastitis or another infection.

■ If the conductivity level is above the conductivity pull off level, 2 green LEDs, 2 yellow LEDs and 1 red LED flash and the ACR ram removes the cluster from the animal. Further investigation of the animal is required to ascertain whether there is mastitis or another infection.

■ If you are milking a mastitic animal, the conductivity warning level indicators can be turned off by pressing and holding the Right / Conductivity key. The conductivity LED will change to red to indicate this.



■ If the user would like the conductivity warning level indicator, but not the cluster removed from the animal, set the conductivity pull off level to the maximum setting of 20.0 millisiemens.

Information about Milk Conductivity Measurement

The electrical conductivity of milk is an indication that there might be an infection within the animal (i.e. mastitis). Scientific research suggests that a healthy cow will have a conductivity measurement in the range of 4.0 to 5.5 millisiemens at 25°C. Therefore, an infection can be assumed at values above 5.5 millisiemens. However, this should be backed up by further testing such as the California Milk Test (CMT) to determine whether there is an infection that needs addressing.

It should be noted that the conductivity measurement provided on the milking point control is a guide and should be treated as such.

NB - The conductivity warning level and pull off level are user settable and therefore can be altered to suit individual farm requirements.



Animal Data

The CR35 Milking Point Control can display warnings and allow the user to edit flags against animals.

Animal Warnings

When the CR35 is linked to the ATL Micro M5 control, animal warnings can be displayed against an animal, the control will flash red led's along the side of the box and display the warning flashing between the animal number and the warning text, the user is required to press the Flag key to acknowledge the warning before being allowed to milk the animal.



Press the Flag key to scroll through the list of warning lockups until they are all acknowledged.



Animal Flags

When the CR35 is linked to the ATL Micro M5 control, animal flags can be edited by pressing the Flag key, the user can then scroll through the available flags (Please note, the displayed flags are controlled from the ATL Micro M5 control) using the Flag key and toggle the displaying flag using the Milk key, pressing any other key will exit the flags display.



Press the Flag key to scroll through the list of available flags.



Press the Milk key to toggle the flag.





Stall selection in Multi-Stall mode

In Multi-stall mode the stall can be selected using the arrow keys, when the animal's number is shown the control will show which stall is selected with the use of an arrow.

Press the left arrow to move to the left in the group of stalls which the control is responsible for milking.



Press the right arrow to move to the right in the group of stalls which the control is responsible for milking.



When milking the left hand stall, after the user selects the stall the animals number will appear with an arrow showing it is the left hand stall.

< 123456

In Multi-Stall configurations with 3 stalls the centre stall is shown using two arrows at each end.

< 123456 >

When milking the right hand stall, the display an arrow on the right.

123456 >



The Washing Procedure

- If the clusters are raised, press the manual key on all milking points to lower them, and then place them into the jetters.
- Press the System Wash key combination (Press the Wash key and the Manual key and hold for 2 seconds) to put the system into wash mode.



- The LCD display will show WASH, the elapsed wash time and the remaining wash time;
- The milking point control will remain in wash mode for the user set wash time period;
- At any point, the user can press the wash button to cancel the washing process;
- At the end of wash mode, the control will idle with all outputs off;
- We recommend that the parlour is cleaned by the circulation of milk stone remover at prevention strength on a weekly basis.





Monthly Routine Maintenance

- Visually inspect the ACR control boxes for damage. Any damage will admit water causing the premature failure of the electronics and should be fixed as soon as possible;
- Inspect the vacuum lines from the control valve for contamination. Any contamination could indicate the Milk Meter flask diaphragm has failed;
- Check the ACR sensor is clean and there is no milk stone build up on the steel rings in the ACR sensor.

Six Monthly Routine Maintenance

- In addition to the above monthly checks, check the ACR ram and make sure it operates smoothly.

Yearly Routine Maintenance

- In addition to the above monthly and six monthly checks, we recommend replacement of the milk meter flask diaphragm, plunger seal, bottom seal, probe grommets, top nipple o-ring and shut-off valve diaphragm.
- Thoroughly inspect the control valve, making sure it is clean and operates correctly. Service as required.

Parlour Wash Down

- The ACR control enclosure is IP65 rated. However, no indirect or direct pressure washing should be used to wash the ACR control unit, as this will cause the seals to fail and water to ingress and damage the electronic components. Please note that water damage is not covered under warranty.



Additional Items Required to Install ACR System

- 8mm ID PVC signal pipe (10mm OD nipple) to connect from control valve to ACR sensor / shut-off valve and from control valve to ACR ram. Length required installation dependent.
- 19mm milk tube for connection to the ACR sensor. The ACR sensor has 21mm OD inlet and outlets.
- Fixings to fix the ACR sensor to the parlour frame.
- Milk line inlets suitable for 19mm milk tube, if not already available.
- Conduit, mounting and cable for wiring to bringing power to the ACR controls.
- If using an existing ACR ram and solenoid, the solenoid must be either 12vDC or 24vDC, with the power supply supplying the correct voltage.